

DH-IPC-HDBW4431F-AS

4MP IR Mini Dome Network Camera



- 1/3" 4Megapixel progressive scan CMOS
- H.265&H.264 dual-stream encoding
- 25/30fps@4M(2688×1520)
- Smart Detection supported
- WDR(120dB), Day/Night(ICR), 3DNR,AWB,AGC,BLC,
- Multiple network monitoring: Web viewer, CMS(DSS/PSS) & DMSS
- 2.8mm fixed lens (3.6mm, 6mm optional)
- Max. IR LEDs Length 20m
- Micro SD memory, IP67, IK10, PoE



System Overview

Eco-savvy products by upgrading H.265 encoding technology, bringing high efficient video compression. It saves bandwidth and storage, energy-saving design to enhance the monitoring system. Meanwhile, the series offers features such as starlight, Smart IR technology, intelligent image analysis techniques. It provides excellent image quality and intelligent and efficient event reminders. This series provides IP67 weatherproof and IK10 vandal-proof protection feature. Give customers more value

Functions

Wide Dynamic Range

Embedded with industry leading wide dynamic range (WDR) technology, vivid pictures are achieved even in the most intense contrast lighting conditions. For applications with both bright and low lighting conditions that change quickly, True WDR (120dB) optimizes both the bright and dark areas of a scene at the same time to provide usable video.

Intelligent Video System (IVS)

With built-in intelligent video analytics, the camera has the ability to detect and analyze moving objects for improved video surveillance. The camera provides optional standard intelligence at the edge allowing detection of multiple object behaviors such as abandoned or missing objects. IVS also supports Tripwire analytics, allowing the camera to detect when a pre-determined line has been crossed, ideal for business intelligence, and Facial Detection, for searching or identification of individuals.

Environmental

With a temperature range of -30 °C to +60 °C (-22 °F to +140 °F), the camera is designed for extreme temperature environments. The camera complies to an IK10 impact rating making it capable of withstanding the equivalent of 55 kg (120 lbs) of force. Subjected and certified to rigorous dust and water immersion tests, the IP67 rating makes it suitable for demanding outdoor applications. For environments with rain, sleet, snow and fog, an integrated wiper provides users with clear visibility at all times.

Protection

Supporting ±30% input voltage tolerance, this camera suits even the most unstable conditions for outdoor applications. Its 4KV lightning rating provides protection against the camera and its structure from the effects of lightning.

Smart H.265+

Deliver high quality video without straining the network, Smart H.265+ is the optimized implementation of H.265. The Smart H.265+ encoding technology includes a scene adaptive encoding strategy, dynamic GOP, dynamic ROI, flexible multi-frame reference structure and intelligent noise reduction, providing saving of up to 70% of bandwidth and storage when compared with standard H.265.

HEVC (H.265)

H.265 ITU-T VCEG is a new video coding standard. H.265 Following standard developed around the existing video coding standard H.264, some retain the original technology, while some of the relevant technology to improve the new technology uses advanced technology to improve the relationship between the code stream, encoding quality, and the delay between algorithm complexity, optimize settings specific contents include: Improve compression efficiency, improve the robustness and error recovery capabilities, real-time to reduce the delay, reduce channel acquisition time and a random access delay, reduce complexity, etc

Technical Specification

Camera

Image Sensor	1/3" 4Megapixel progressive scan CMOS
Effective Pixels	2688(H)x1520(V)
RAM/ROM	512MB/32MB
Scanning System	Progressive
Electronic Shutter Speed	Auto/Manual, 1/3(4)~1/100000s
Minimum Illumination	0.08Lux/F2.0(Color,1/3s,30IRE) 0.3Lux/2.0(Color,1/30s,30IRE) 0Lux/F2.0(IR on)
S/N Ratio	More than 50dB
IR Distance	Distance up to 20m (66ft)
IR On/Off Control	Auto/ Manual
IR LEDs	10

Lens

Lens Type	Fixed				
Mount Type	Board-in				
Focal Length	2.8mm (3.6mm, 6mm optional)				
Max. Aperture	F2.0 (F2.0, F2.0)				
Angle of View	H: 104° (87°, 55°), V: 57° (48°, 31°)				
Optical Zoom	N/A				
Focus Control	Fixed				
Close Focus Distance	N/A				
DORI Distance	Lens	Detect	Observe	Recognize	Identify
	2.8 mm	63m(207ft)	25m(82ft)	13m(43ft)	6m(20ft)
	3.6 mm	80m(262ft)	32m(105ft)	16m(52ft)	8m(26ft)
	6.0 mm	117m(384ft)	47m(154ft)	23m(75ft)	12m(39ft)

Pan/Tilt/Rotation

Pan/Tilt/Rotation Range	Pan:0°~60°; Tilt:0°~80°; Rotation:0°~360°
-------------------------	---

Intelligence

IVS	Tripwire, Intrusion, Object Abandoned/Missing
Advanced Intelligent Functions	Face Detection

Video

Compression	H.265+/H.265/H.264+/H.264
Streaming Capability	3 Streams
Resolution	4M(2688x1520)/3M(2304x1296)/ 1080P(1920x1080)/1.3M(1280x960)/ 720P(1280x720)/D1(704x576/704x480)/ VGA(640x480)/CIF(352x288/352x240)
Frame Rate	Main Stream: 4M(1~25/30fps)
	Sub Stream: D1(1~25/30fps)
	Third Stream: 720P(1~25/30fps)
Bit Rate Control	CBR/VBR
Bit Rate	H.264: 24~10240Kbps H.265: 14~9984Kbps
Day/Night	Auto(ICR) / Color / B/W
BLC Mode	BLC / HLC / WDR(120dB)

White Balance	Auto/Natural/Street Lamp/Outdoor/Manual
Gain Control	Auto/Manual
Noise Reduction	3D DNR
Motion Detetion	Off / On (4 Zone, Rectangle)
Region of Interest	Off / On (4 Zone)
Electronic Image Stabilization (EIS)	N/A
Smart IR	Support
Defog	N/A
Digital Zoom	16x
Flip	0°/90°/180°/270°
Mirror	Off / On
Privacy Masking	Off / On (4 Area, Rectangle)

Audio

Compression	G.711a/ G.711Mu/ AAC/ G.726
-------------	-----------------------------

Network

Ethernet	RJ-45 (10/100Base-T)
Protocol	HTTP; HTTPS; TCP; ARP; RTSP; RTP; UDP; SMTP; FTP; DHCP; DNS; DDNS; PPPoE; IPv4/v6; QoS; UPnP;NTP; Bonjour; 802.1x; Multicast; ICMP; IGMP; SNMP
Interoperability	ONVIF, PSIA, CGI
Streaming Method	Unicast / Multicast
Max. User Access	10 Users /20 Users
Edge Storage	NAS Local PC for instant recording Mirco SD card 128GB
Web Viewer	IE, Chrome, Firefox, Safari
Management Software	Smart PSS, DSS, Easy4ip
Smart Phone	IOS, Android

Certifications

Certifications	CE (EN 60950:2000) UL:UL60950-1 FCC: FCC Part 15 Subpart B
----------------	--

Interface

Video Interface	N/A
Audio Interface	Built-in Mic
RS485	N/A
Alarm	N/A

Electrical

Power Supply	DC12V, PoE (802.3af)(Class 0)
Power Consumption	<4.5W

Environmental

Operating Conditions	-30° C ~ +60° C (-22° F ~ +140° F) / Less than 95% RH
Storage Conditions	-30° C ~ +60° C (-22° F ~ +140° F) / Less than 95% RH
Ingress Protection	IP67
Vandal Resistance	IK10

Construction

Casing	Metal
Dimensions	Φ106mm×50.3mm (4.17"×1.98")
Net Weight	0.4kg (0.88lb)
Gross Weight	0.44kg (0.97lb)

Ordering Information

Type	Part Number	Description
4MP camera	DH-IPC-HDBW4431FP-AS-0360B	4MP IR Mini Dome Network Camera,WDR,PAL
	DH-IPC-HDBW4431FN-AS-0360B	4MP IR Mini Dome Network Camera,WDR,NTSC
	IPC-HDBW4431FP-AS-0360B	4MP IR Mini Dome Network Camera,WDR,PAL
	IPC-HDBW4431FN-AS-0360B	4MP IR Mini Dome Network Camera,WDR,NTSC
	DH-IPC-HDBW4431FP-AS-0280B	4MP IR Mini Dome Network Camera,WDR,PAL
	DH-IPC-HDBW4431FN-AS-0280B	4MP IR Mini Dome Network Camera,WDR,NTSC
	IPC-HDBW4431FP-AS-0280B	4MP IR Mini Dome Network Camera,WDR,PAL
	IPC-HDBW4431FN-AS-0280B	4MP IR Mini Dome Network Camera,WDR,NTSC
	DH-IPC-HDBW4431FP-AS-0600B	4MP IR Mini Dome Network Camera,WDR,PAL
	DH-IPC-HDBW4431FN-AS-0600B	4MP IR Mini Dome Network Camera,WDR,NTSC
	IPC-HDBW4431FP-AS-0600B	4MP IR Mini Dome Network Camera,WDR,PAL
	IPC-HDBW4431FN-AS-0600B	4MP IR Mini Dome Network Camera,WDR,NTSC
	Accessories (optional)	PFB204W
PFA139		Junction box
PFA152		Pole mount

Accessories

Optional:



PFA139 Junction Box



PFB204W Wall Mount



PFA152 Pole Mount

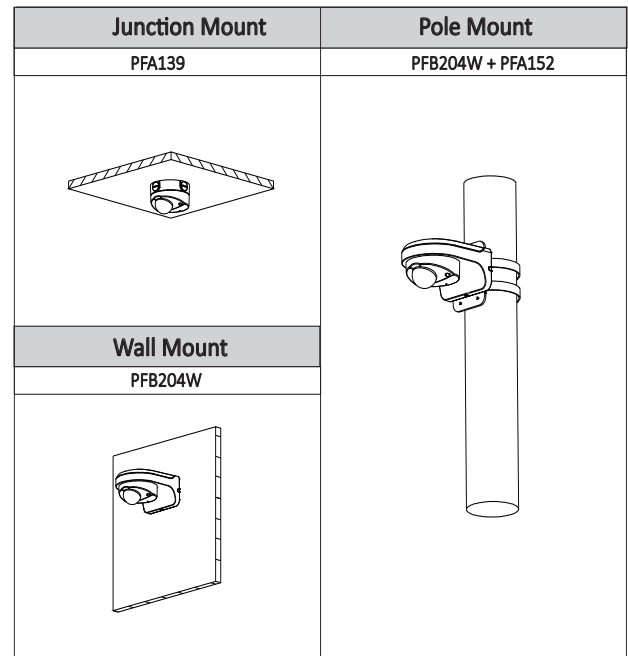

Dimensions (mm/inch)

